

1. On a separate sheet, draw the object shown here.

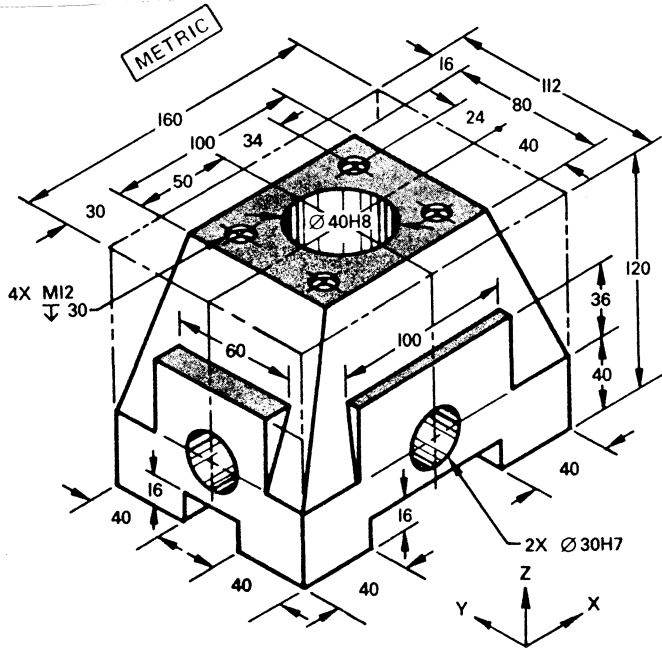

2. On a separate sheet, draw the object shown here.

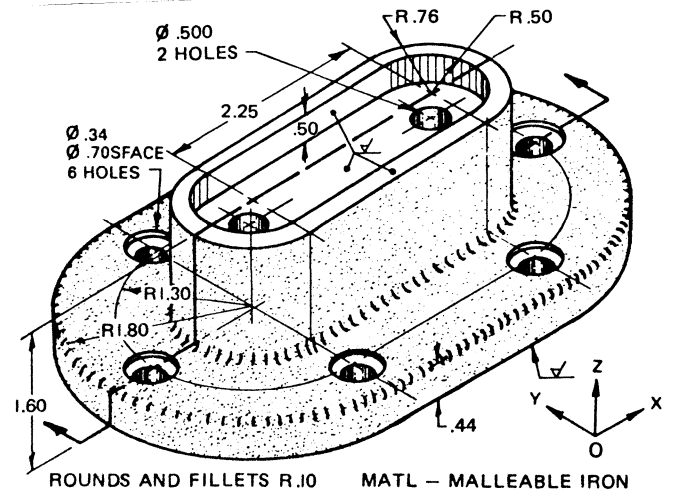

3. On a separate sheet, draw the object shown here.

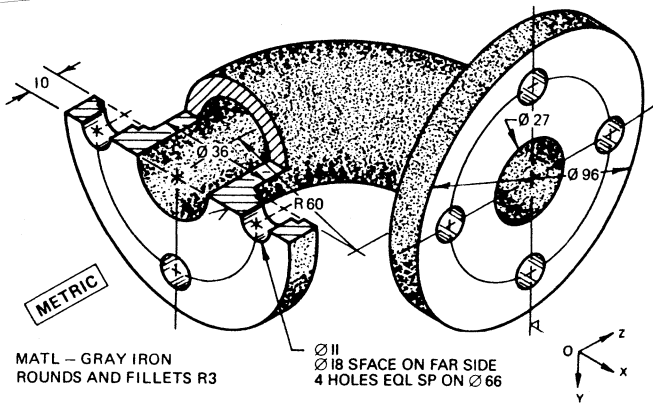

4. On a separate sheet, draw the object shown here.

